

PHILIPS

hue personal wireless lighting

Tap dial switch



User manual
Benutzerhandbuch
Notice d'emploi
Manual de usuario
Manual do usuário
Manuale d'uso

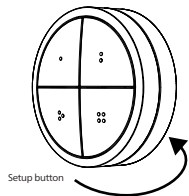
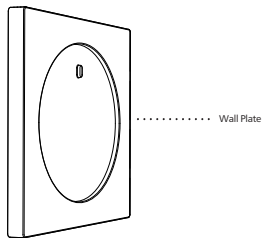
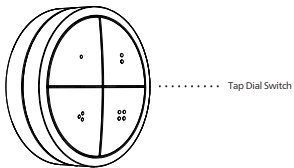

1



www.philips-hue.com/connectproduct



2a

2a > 3

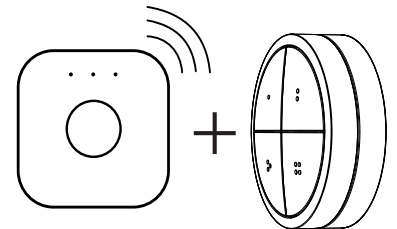

2b

2b > 4

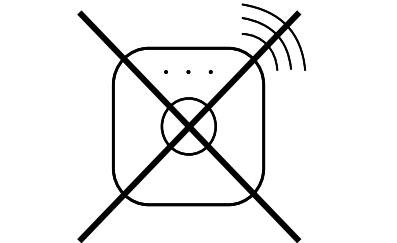

3

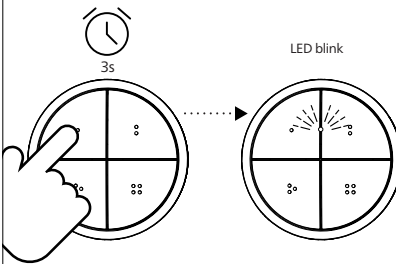

!

> 9

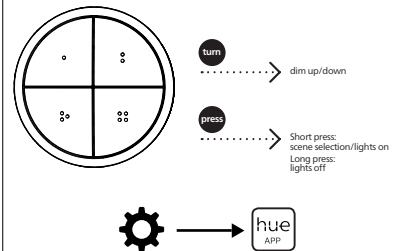

!

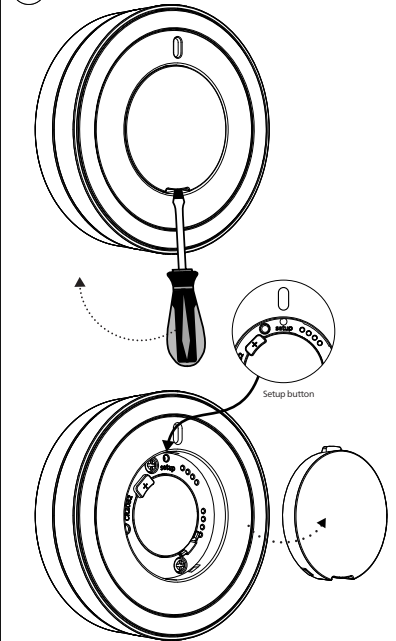

4

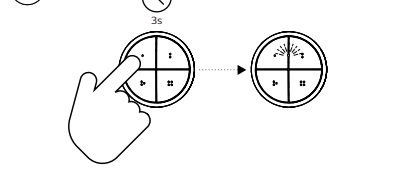

5

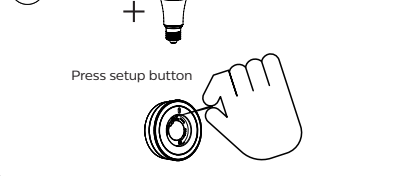

6

