

ADJ

Ultra Bar 12

©2013 ADJ Products, LLC all rights reserved. Information, specifications, diagrams, images, and instructions herein are subject to change without notice. ADJ Products, LLC logo and identifying product names and numbers herein are trademarks of ADJ Products, LLC. Copyright protection claimed includes all forms and matters of copyrightable materials and information now allowed by statutory or judicial law or hereinafter granted. Product names used in this document may be trademarks or registered trademarks of their respective companies and are hereby acknowledged. All non-ADJ Products, LLC brands and product names are trademarks or registered trademarks of their respective companies.

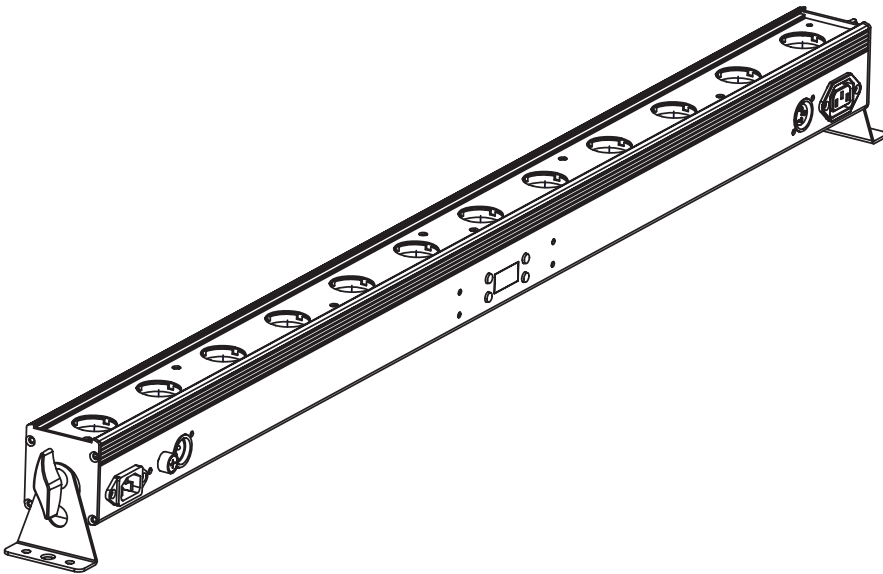

ADJ Products, LLC and all affiliated companies hereby disclaim any and all liabilities for property, equipment, building, and electrical damages, injuries to any persons, and direct or indirect economic loss associated with the use or reliance of any information contained within this document, and/or as a result of the improper, unsafe, insufficient and negligent assembly, installation, rigging, and operation of this product.

User Instructions

Ultra Bar 12

Introduction

Unpacking: Thank you for purchasing the Ultra Bar 12 by ADJ Products, LLC. Every Ultra Bar 12 has been thoroughly tested and has been shipped in perfect operating condition. Carefully check the shipping carton for damage that may have occurred during shipping. If the carton appears to be damaged, carefully inspect your fixture for any damage and be sure all accessories necessary to operate the unit has arrived intact. In the case damage has been found or parts are missing, please contact our toll free customer support number for further instructions. Do not return this unit to your dealer without first contacting customer support.

Introduction: The ADJ Ultra Bar 12 is a professional grade indoor linear wash bar. This fixture can be used in a stand alone mode or connected in a Master/Slave configuration. This wash has six operating modes: Sound Active mode, Auto mode, Program mode, RGB Dimmer mode, Static Color mode, and DMX control mode.

Customer Support: ADJ Products, LLC provides a customer support line, to provide set up help and to answer any question should you encounter problems during your set up or initial operation. You may also visit us on the web at www.adj.com for any comments or suggestions. Service Hours are Monday through Friday 8:00 a.m. to 4:30 p.m. Pacific Standard Time.

Voice: (800) 322-6337
Fax: (323) 582-2941
E-mail: support@adj.com

Warning! To prevent or reduce the risk of electrical shock or fire, do not expose this unit to rain or moisture.

Caution! There are no user serviceable parts inside this unit. Do not attempt any repairs yourself, doing so will void your manufactures warranty. In the unlikely event your unit may require service please contact ADJ Products, LLC.

PLEASE recycle the shipping carton when ever possible.

Ultra Bar 12

Features

- Multicolors
- Six Operating Modes
- Electronic Dimming 0-100%
- Built in Microphone
- DMX-512 protocol
- 3-Pin DMX Connection
- 9 DMX Modes: 3 Channel Mode, 5 Channel Mode, 6 Channel Mode, 7 Channel Mode, 8 Channel Mode, 9 Channel Mode, 11 Channel Mode, 18 Channel Mode and 20 Channel Mode
- ADJ RFC compatible (Not Included)
- Power Cord Daisy Chain (See page 27)

Ultra Bar 12

Warranty Registration

The Ultra Bar 12 carries a 3 year limited warranty. Please fill out the enclosed warranty card to validate your purchase. All returned service items whether under warranty or not, must be freight pre-paid and accompany a return authorization (R.A.) number. The R.A. number must be clearly written on the outside of the return package. A brief description of the problem as well as the R.A. number must also be written down on a piece of paper included in the shipping carton. If the unit is under warranty, you must provide a copy of your proof of purchase invoice. You may obtain a R.A. number by contacting our customer support team on our customer support number. All packages returned to the service department not displaying a R.A. number on the outside of the package will be returned to the shipper.

Ultra Bar 12

Installation

The unit should be mounted using a mounting clamp (not provided), affixing it to the mounting bracket that is provided with the unit. Always ensure that the unit is firmly fixed to avoid vibration and slipping while operating. Always ensure that the structure to which you are attaching the unit is secure and is able to support a weight of 10 times the unit's weight. Also, always use a safety cable that can hold 12 times the weight of the unit when installing the fixture. The equipment must be installed by a professional, and it must be installed in a place where it is out of the reach of people's grasp.

- To reduce the risk of electrical shock or fire, do not expose this unit rain or moisture
- Do not spill water or other liquids into or on to your unit.
- Do not attempt to operate this unit if the power cord has been frayed or broken. Do not attempt to remove or break off the ground prong from the electrical cord. This prong is used to reduce the risk of electrical shock and fire in case of an internal short.
- Disconnect from main power before making any type of connection.
- Do not remove the cover under any conditions. There are no user serviceable parts inside.
- Never operate this unit when it's cover is removed.
- Never plug this unit in to a dimmer pack
- Always be sure to mount this unit in an area that will allow proper ventilation. Allow about 6" (15cm) between this device and a wall.
- Do not attempt to operate this unit, if it becomes damaged.
- This unit is intended for indoor use only, use of this product out doors voids all warranties.
- During long periods of non-use, disconnect the unit's main power.
- Always mount this unit in safe and stable matter.
- Power-supply cords should be routed so that they are not likely to be walked on or pinched by items placed upon or against them, paying particular attention to the point they exit from the unit.
- Cleaning -The fixture should be cleaned only as recommended by the manufacturer. See page 28 for cleaning details.
- Heat -The appliance should be situated away from heat sources such as radiators, heat registers, stoves, or other appliances (including amplifiers) that produce heat.
- The fixture should be serviced by qualified service personnel when:
 - A. The power-supply cord or the plug has been damaged.
 - B. Objects have fallen, or liquid has been spilled into the appliance.
 - C. The appliance has been exposed to rain or water.
 - D. The appliance does not appear to operate normally or exhibits a marked change in performance.

Power Supply: The ADJ Ultra Bar 12 contains a automatic voltage switch, which will auto sense the voltage when it is plugged into the power source. With this switch there is no need to worry about the correct power voltage, this unit can be plugged in anywhere.

DMX-512: DMX is short for Digital Multiplex. This is a universal protocol used as a form of communication between intelligent fixtures and controllers. A DMX controller sends DMX data instructions from the controller to the fixture. DMX data is sent as serial data that travels from fixture to fixture via the DATA "IN" and DATA "OUT" XLR terminals located on all DMX fixtures (most controllers only have a DATA "OUT" terminal).

DMX Linking: DMX is a language allowing all makes and models of different manufactures to be linked together and operate from a single controller, as long as all fixtures and the controller are DMX compliant. To ensure proper DMX data transmission, when using several DMX fixtures try to use the shortest cable path possible. The order in which fixtures are connected in a DMX line does not influence the DMX addressing. For example; a fixture assigned a DMX address of 1 may be placed anywhere in a DMX line, at the beginning, at the end, or anywhere in the middle. When a fixture is assigned a DMX address of 1, the DMX controller knows to send DATA assigned to address 1 to that unit, no matter where it is located in the DMX chain.

Data Cable (DMX Cable) Requirements (For DMX Operation): The Ultra Bar 12 can be controlled via DMX-512 protocol. The Ultra Bar 12 has 9 DMX channel modes, please see pages 9-10 for the different modes. The DMX address is set on the back panel of the Ultra Bar 12.

Your unit and your DMX controller require a standard 3-pin XLR connector for data input and data output (Figure 1). We recommend Accu-Cable DMX cables. If you are making your own cables, be sure to use standard 110-120 Ohm shielded cable (This cable may be purchased at almost all pro lighting stores). Your cables should be made with a male and female XLR connector on either end of the cable. Also remember that DMX cable must be daisy chained and cannot be split.



Figure 1

Notice: Be sure to follow figures two and three when making your own cables. Do not use the ground lug on the XLR connector. Do not connect the cable's shield conductor to the ground lug or allow the shield conductor to come in contact with the XLR's outer casing. Grounding the shield could cause a short circuit and erratic behavior.

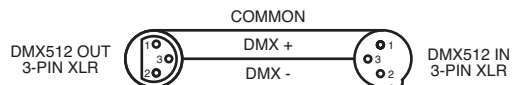

Figure 2

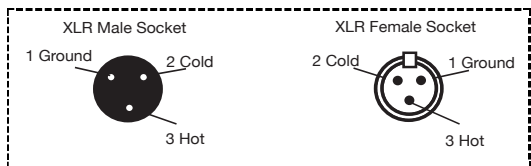

Figure 3

XLR Pin Configuration	
Pin 1 =	Ground
Pin 2 =	Data Compliment (negative)
Pin 3 =	Data True (positive)

Special Note: Line Termination. When longer runs of cable are used, you may need to use a terminator on the last unit to avoid erratic behavior. A terminator is a 110-120 ohm 1/4 watt resistor which is connected between pins 2 and 3 of a male XLR connector (DATA + and DATA -). This unit is inserted in the female XLR connector of the last unit in your daisy chain to terminate the line. Using a cable terminator (ADJ part number Z-DMX/T) will decrease the possibilities of erratic behavior.



Termination reduces signal errors and avoids signal transmission problems and interference. It is always advisable to connect a DMX terminal. (Resistance 120 Ohm 1/4 W) between PIN 2 (DMX-) and PIN 3 (DMX +) of the last fixture.

Figure 4

5-Pin XLR DMX Connectors. Some manufactures use 5-pin DMX-512 data cables for DATA transmission in place of 3-pin. 5-pin DMX fixtures may be implemented in a 3-pin DMX line. When inserting standard 5-pin data cables in to a 3-pin line a cable adaptor must be used, these adaptors are readily available at most electric stores. The chart below details a proper cable conversion.

3-Pin XLR to 5-Pin XLR Conversion		
Conductor	3-Pin XLR Female (Out)	5-Pin XLR Male (In)
Ground/Shield	Pin 1	Pin 1
Data Compliment (- signal)	Pin 2	Pin 2
Data True (+ signal)	Pin 3	Pin 3
Not Used		Do Not Use
Not Used		Do Not Use

LED Display On/Off:

To set the LED display to turn off after 20 seconds, press the MODE and DOWN buttons at the same time. Now the display will disappear after 20s. Press any button to turn the display on again. To allow the display to stay On at all times, press the MODE and UP buttons at the same time.

Operating Modes:

The Ultra Bar 12 has six operating modes:

- Sound-Active mode - The unit will react to sound, chasing through the built in programs.
- Built-In Program - There are 22 built-in programs to choose from.
- Static Color Mode - There are 35 colors to choose from.
- Auto Mode - A auto program will run with adjustable fade speed.
- RGB Mode - Choose one of the four colors to remain static or adjust the intensity of each color to make your desired color.
- DMX control mode - This function will allow you to control each individual fixtures traits with a standard DMX 512 controller.

Static Color Mode:

1. Plug the fixture in and press the MODE button until "C0.XX" is displayed.
2. There are 35 colors to choose from. Select your desired color by pressing the UP and DOWN buttons. After you have selected your desired color you can activate strobing by pressing the SET UP button to enter the Flash (strobe) mode.
3. "FS.XX" will now be displayed, this is Flash mode. The Flash can be adjusted between "FS.00" (flash off) to "FS.15" (fastest flash).

RGB Dimmer Mode:

1. Plug the fixture in and press the MODE button until "r.XXX" is displayed. Then press the SET UP button to scroll through RGB colors.
2. When "r.XXX" is displayed you are in Red dimming mode. Press the UP and DOWN buttons to adjust intensity.
3. When "G.XXX" is displayed you are in Green dimming mode. Press the UP and DOWN buttons to adjust intensity.
4. When "b.XXX" is displayed you are in Blue dimming mode. Press the UP and DOWN buttons to adjust intensity.

- After you have adjusted the RGB colors to make your desired color you can then activate strobing by pressing the SET UP button to enter the Flash (strobe) mode.
- “FS.XX” will be displayed, this is Flash mode. The Flash can be adjusted between “FS.00” (flash off) to “FS.15” (fastest flash).

Built-In Program Mode:

- Plug the fixture in and press the MODE button until “Pr.XX” is displayed. “XX” represents a number from 1-22. Use the UP or DOWN buttons to scroll through the 22 programs. Programs 21 and 22 have adjustable colors. Once you have found your desired program press the SET UP button.
- Pressing the SET UP button will display “SP.XX”. When this is displayed you can adjust the running speed of your desired program. Use the UP or DOWN button to adjust the speed between “SP.01” (slowest) and “SP.99” (fastest). Once you have set your desired running speed, you can press the SET UP button to enter the Fade adjustment mode.
- Pressing the SET UP button will display “Fd.XX”. When this is displayed you can adjust the fade speed of your desired program. Use the UP or DOWN button to adjust the speed between “Fd.01” (fastest) and “Fd.99” (slowest) or “Fd.00” (Off). Once you have set your desired fade speed, you can press the SET UP button to enter the Flash (Strobe) mode.
- After pressing SET UP, “FS.XX” will be displayed, this is Flash mode. The Flash can be adjusted between “FS.00” (flash off) to “FS.15” (fastest flash).
 - PROGRAMS 21 & 22** - If you have chosen programs 21 or 22, after the Flash mode, press the SET UP button. “C1.XX” will be displayed. This is the base color, use the UP and DOWN buttons to scroll through the 7 colors. Once you have chosen your base color, press the SET UP button again so that “C2.XX” is displayed. This is the moving color, use the UP and DOWN buttons to scroll through the 7 colors.

Sound Active Mode:

In this mode the Ultra Bar 12 will react to sound, and chase through the different colors.

- Plug the fixture in and press the MODE button until “SU.XX” is displayed. “XX” represents the sound sensitivity level.

- Use the UP or DOWN buttons to adjust the sound sensitivity. “SU.00” is off, “SU.01” is the lowest sensitivity, and “SU.31” is the highest. After adjusting the sound sensitivity, press SET UP if you wish to activate the Flash mode.
- “FS.XX” will now be displayed, this is Flash mode. The Flash can be adjusted between “FS.00” (flash off) to “FS.15” (fastest flash).

Auto Run Mode:

In this mode the Ultra Bar 12 will run a auto program.

- Plug the fixture in and press the MODE button until “AUTO” is displayed.
- After you have activated Auto Run mode, press the SET UP button to adjust the fade time.
- Once you press SET UP “Fd.XX” should be displayed. Use the UP or DOWN buttons to set the fade speed to either “Fd.00” (fade off) or between “Fd.01” (fastest speed) and “Fd.99” (slowest speed). After adjusting the fade speed, press SET UP if you wish to activate the Flash mode.
- “FS.XX” will now be displayed, this is Flash mode. The Flash can be adjusted between “FS.00” (flash off) to “FS.15” (fastest flash).

DMX Mode:

Operating through a DMX controller gives the user the freedom to create their own programs tailored to their own individual needs. This function also allows you to use your fixtures as spot lights. The Ultra Bar 12 has 9 DMX modes: 3 Channel mode, 5 Channel mode, 6 Channel mode, 7 Channel mode, 8 Channel mode, 9 Channel mode, 11 Channel mode, 18 Channel mode, and a 20 Channel mode. See pages 15-25 for each modes’ DMX traits.

Note: 9 Channel mode and 11 Channel mode can only be accessed when the unit is in 3 Section mode. 18 Channel mode and 20 Channel mode can only be accessed when the unit is in 6 Section mode.

- This function will allow you to control each individual fixture’s traits with a standard DMX 512 controller.
- To run your fixture in DMX mode press the MODE button until “d.XXX” is displayed. “XXX” represents the current displayed address. Use the UP or DOWN buttons to select your desired DMX address, then press the SETUP button so that “Ch.XX” is displayed.

3. Use the UP or DOWN buttons to scroll through the DMX Channel modes. The Channel modes are listed below:
 - To run the 3 Channel Mode, press the MODE button until “Ch.03” is displayed. This is the 3 Channel DMX Mode.
 - To run the 5 Channel Mode, press the MODE button until “Ch.05” is displayed. This is the 5 Channel DMX Mode.
 - To run the 6 Channel Mode, press the MODE button until “Ch.06” is displayed. This is the 6 Channel DMX Mode.
 - To run the 7 Channel Mode, press the MODE button until “Ch.07” is displayed. This is the 7 Channel DMX Mode.
 - To run the 8 Channel Mode, press the MODE button until “Ch.08” is displayed. This is the 8 Channel DMX Mode.
 - To run the 9 Channel Mode, press the MODE button until “Ch.09” is displayed. This is the 9 Channel DMX Mode.
9 Channel mode is only available when the unit is in 3 Section Mode. See page 13 to set the 3 Section Mode.
 - To run the 11 Channel Mode, press the MODE button until “Ch.11” is displayed. This is the 11 Channel DMX Mode.
11 Channel mode is only available when the unit is in 3 Section Mode. See page 13 to set the 3 Section Mode.
 - To run the 18 Channel Mode, press the MODE button until “Ch.18” is displayed. This is the 18 Channel DMX Mode.
18 Channel mode is only available when the unit is in 6 Section Mode. See page 13 to set the 6 Section Mode.
 - To run the 20 Channel Mode, press the MODE button until “Ch.20” is displayed. This is the 20 Channel DMX Mode.
20 Channel mode is only available when the unit is in 6 Section Mode. See page 13 to set the 6 Section Mode.
4. Please see pages 15-25 for DMX values and traits.
5. After you have chosen your desired DMX Channel mode plug in the fixture via the XLR connections to any standard DMX controller.

Default Running Mode:

This is a default running mode. When this mode is activated all modes will return to their default settings and a Auto program will run.

1. Plug the fixture in and press the MODE and SET UP buttons at the same time.

ADJ RFC:

This function is used to activate and deactivate the ADJ RFC (Remote Control). When this function is activated you can control the fixture using the ADJ RFC. Please see the next page for ADJ RFC controls and functions.

1. Plug the fixture in and press the MODE button until “Auto” is displayed.
2. Press the SET UP button until “rF.XX” is displayed. “XX” represents either “on” or “oF”.
3. Press the UP or DOWN buttons to either activate the remote function (On) or deactivate it (Off).

Dimming Curve:

This is used to set the dimming curve used with DMX mode. See page 26 for the different dimming curves. The dimming curves are in the order they appear in the unit.

1. Plug the fixture in and press the MODE button until the DMX address is displayed.
2. Press the SET UP button until “dr-X” is displayed. This is the dimmer setting. “X” represents the dimming mode.
3. Use the UP and DOWN buttons to find your desired dimming curve. Press SET UP when you are finished.

Master-Slave Configuration:

This function will allow you to link units together to run in a Master-Slave mode. In Master-Slave operation one unit will act as the controlling unit and the others will react to the controlling units built-in programs. Any unit can act as a Master or as a Slave however, only one unit can be programmed to act as the “Master.”

Master-Slave Connections and Settings:

1. Daisy chain your units via the XLR connector on the rear of the unit. Use standard XLR data cables to link your units together. Remember that the Male XLR connector is the input and the Female XLR connector is the output. The first unit in the chain (master) will use the female XLR connector only. The last unit in the chain will use the male XLR connector only.
2. Set the “Master” unit to your desired operating mode and then connect the “Slave” unit or units.
3. For the “Slave” unit(s) press the MODE button until “SLAu” is displayed. The “Slave” unit(s) will now follow the “Master” unit.

3 Section & 6 Section Mode:

The Ultra Bar 12 can be switched between a 3 section mode and a 6 section mode. The pixels will chase/move through these sections. These section modes work with the Built-In Programs 4 and 6-22 and certain DMX Channel modes.

1. Before powering on the unit, press and hold the MODE and UP buttons. While you are pressing these buttons apply power. Either “Adj3” (3 Section mode) or “Adj6” (6 Section mode) will be displayed.
2. If the mode that is displayed is not the mode that you wanted, unplug the unit and repeat step 1.

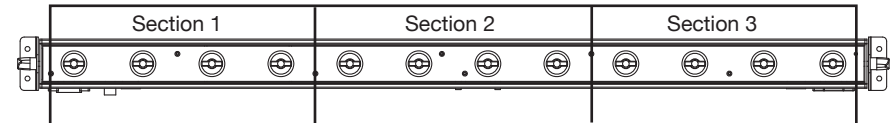
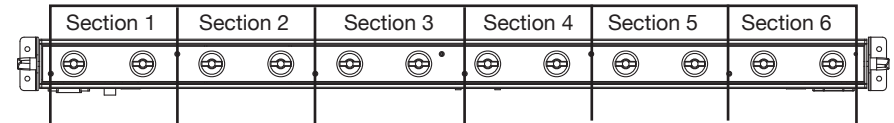
3 Section Mode**6 Section Mode**

Ultra Bar 12

ADJ RFC Operation

The **ADJ RFC** remote (sold separately) has many different functions and allows you to control your Ultra Bar 12 from long distance. The **ADJ RFC** remote can control your system up to 150 ft. To use the RFC you must first activate the fixtures receiver, to activate the receiver please see the instructions on page 10.

BLACKOUT - Pressing this button will blackout the fixture. Press this button for more than 3 seconds to activate default running mode. All modes will return to their default settings.

AUTO RUN - This button will run an automatic program. You can control the fade speed of the Auto Run by pressing the Flash button twice and then adjust the speed using the “+” and “-” buttons. Press the Flash button once to enter Flash mode and use the “+” and “-” buttons to adjust the Flash speed.

PROGRAM SELECTION - This button will activate 1 of 2 modes; Color Select mode or Built-In Programs.

1. Press this button to activate Color Static mode. Use the “+” or “-” to scroll through the 35 colors. Once you have found your color, you can press the Flash Button to activate strobing and use the “+” or “-” to adjust the Flash rate.

2. Press this button to enter Built-In Program mode. Use the “+” or “-” to scroll through the 22 built-in programs. Once you have found your desired program and you can press the SPEED button and then use the “+” and “-” buttons to adjust the program speed. You can press the Flash Button to activate strobing and use the “+” or “-” to adjust the Flash rate. Press the Flash button twice to enter the Fade speed adjustment and use the “+” and “-” buttons to adjust the Fade speed.

FLASH - This button will activate the flash (strobe) effect. You can control the flash speed by pressing the “+” and “-” buttons. Pressing this button again will activate fade mode (if available). You can adjust the fade speed by pressing the “+” and “-” buttons.

SPEED - Press this button and use the “+” & “-” buttons to adjust the speed of the Built-In Programs.

SOUND ACTIVE - This button activates sound active mode. Use the “+” & “-” buttons to adjust the sound sensitivity level.

R G B - Press either one of these buttons and then press the “+” or “-” to adjust the brightness.

“+” and “-” - Use these buttons to adjust the flash rate, speed of the Auto Run and built in programs, fade speed, sound sensitivity, and output intensity. Use these buttons to scroll through the static colors and built-In programs.

Ultra Bar 12

3 Channel Mode

Channel	Value	Function
1	0 - 255	RED 0% - 100%
2	0 - 255	GREEN 0% - 100%
3	0 - 255	BLUE 0% - 100%

Ultra Bar 12

5 Channel Mode

Channel	Value	Function
1	0 - 255	RED 0% - 100%
2	0 - 255	GREEN 0% - 100%
3	0 - 255	BLUE 0% - 100%
4	0 - 15 16 - 255	STROBING NOTHING STROBING SLOW - FAST
5	0 - 255	MASTER DIMMER 0% - 100%

Ultra Bar 12		6 Channel Mode
Channel	Value	Function
1	0 - 255	RED 0% - 100%
2	0 - 255	GREEN 0% - 100%
3	0 - 255	BLUE 0% - 100%
4	0 - 255	COLOR MACROS (Please see the color macro chart page 26)
5	0 - 15 16 - 255	STROBING NOTHING STROBING SLOW - FAST
6	0 - 255	MASTER DIMMER 0% - 100%

Channels 1, 2, & 3 will not work, when Channel 4 is being used.

Ultra Bar 12		7 Channel Mode
Channel	Value	Function
1	0 - 255	RED 0% - 100%
2	0 - 255	GREEN 0% - 100%
3	0 - 255	BLUE 0% - 100%
4	0 - 255	MASTER DIMMER 0% - 100%
5	0 - 15 16 - 255 0 - 255 0 - 255	STROBING/PROGRAM SPEED/SOUND <u>SENSITIVITY ADJUSTMENTS</u> NOTHING STROBING SLOW - FAST PROGRAM SPEED SLOW - FAST SOUND SENSITIVITY LEAST - MOST
6	0 - 51 52 - 102 103 - 204 205 - 255	<u>DIMMING/COLOR MACRO/ PROGRAM MODE/SOUND ACTIVE</u> DIMMER MODE COLOR MACRO MODE PROGRAM MODE SOUND ACTIVE MODE
7	0 - 255 0 - 24 25 - 35 36 - 46 47 - 57 58 - 68 69 - 79 80 - 90 91 - 101 102 - 112 113 - 123	COLOR MACROS & PROGRAMS COLOR MACROS (See the Color Macro Chart on page 26) PROGRAM 1 PROGRAM 2 PROGRAM 3 PROGRAM 4 PROGRAM 5 PROGRAM 6 PROGRAM 7 PROGRAM 8 PROGRAM 9 PROGRAM 10

Ultra Bar 12		7 Channel Mode
Channel	Value	Function
7		PROGRAMS CONT.
	124 - 134	PROGRAM 11
	135 - 145	PROGRAM 12
	146 - 156	PROGRAM 13
	157 - 167	PROGRAM 14
	168 - 178	PROGRAM 15
	179 - 189	PROGRAM 16
	190 - 200	PROGRAM 17
	201 - 211	PROGRAM 18
	212 - 222	PROGRAM 19
	223 - 233	PROGRAM 20
	234 - 244	PROGRAM 21
	245 - 255	PROGRAM 22

When Channel 7 is between the values of 234 - 255 (Programs 21 & 22), Channel 3 will let you select a flow color, and Channel 4 will let you select a base color. Channel 5 will control the speed of the flow color. See the Color Macro Chart on page 26 to select your flow color and base color.

When Channel 6 is between the values of 0-51, Channels 1-3 are used, and Channel 5 will control strobing.

When Channel 6 is between the values of 52-102, Channel 7 is in Color Macros Mode, and Channel 5 will control strobing.

When Channel 6 is between the values of 103-204, Channel 7 is in Program Mode, and Channel 5 will control the program speed.

When Channel 6 is between the values of 205-255, Channel 7 is in Sound Active Mode, and Channel 5 will control the sound sensitivity.

Ultra Bar 12		8 Channel Mode
Channel	Value	Function
1	0 - 255	RED 0% - 100%
2	0 - 255	GREEN 0% - 100%
3	0 - 255	BLUE 0% - 100%
4	0 - 255	COLOR MACROS (See the Color Macro Chart on page 26)
5	0 - 15	PROGRAMS
	16 - 25	NO FUNCTION
	26 - 35	PROGRAM 1
	36 - 45	PROGRAM 2
	46 - 55	PROGRAM 3
	56 - 65	PROGRAM 4
	66 - 75	PROGRAM 5
	76 - 85	PROGRAM 6
	86 - 95	PROGRAM 7
	96 - 105	PROGRAM 8
	106 - 115	PROGRAM 9
	116 - 125	PROGRAM 10
	126 - 135	PROGRAM 11
	136 - 145	PROGRAM 12
	146 - 155	PROGRAM 13
	156 - 165	PROGRAM 14
	166 - 175	PROGRAM 15
	176 - 185	PROGRAM 16
	186 - 195	PROGRAM 17
	196 - 205	PROGRAM 18
	206 - 215	PROGRAM 19
	216 - 225	PROGRAM 20
	226 - 235	PROGRAM 21
	236 - 245	PROGRAM 22
	246 - 255	AUTO RUN SOUND ACTIVE

Ultra Bar 12		8 Channel Mode
Channel	Value	Function
6	0 - 255 0 - 255	PROGRAM SPEED/SOUND SENSITIVE PROGRAM SPEED SLOW - FAST SOUND SENSITIVITY LEAST SENSITIVE - MOST SENSITIVE
7	0 - 15 16 - 255	STROBING NOTHING STROBING SLOW - FAST
8	0 - 255	MASTER DIMMER 0% - 100%

When Channel 5 is between the values of 216 - 235 (Programs 21 & 22), Channel 3 will let you select a flow color, and Channel 4 will let you select a base color. Channel 6 will control the speed of the flow color. See the Color Macro Chart on page 26 to select your flow color and base color.

When Channel 4 is being used, Channels 1-3 will not function.

When Channel 5 is between the values of 16-245, Channel 6 will control the program speed.

When Channel 6 is between the values of 246-255, Channel 6 will control the sound sensitivity.

Ultra Bar 12		9 Channel Mode
Channel	Value	Function
1	0 - 255	RED 1-4 0% - 100%
2	0 - 255	GREEN 1-4 0% - 100%
3	0 - 255	BLUE 1-4 0% - 100%
4	0 - 255	RED 5-8 0% - 100%
5	0 - 255	GREEN 5-8 0% - 100%
6	0 - 255	BLUE 5-8 0% - 100%
7	0 - 255	RED 9-12 0% - 100%
8	0 - 255	GREEN 9-12 0% - 100%
9	0 - 255	BLUE 9-12 0% - 100%

This DMX Channel mode can only be used when the unit is set to 3 Section Mode. See page 13.

Ultra Bar 12		11 Channel Mode
Channel	Value	Function
1	0 - 255	RED 1-4 0% - 100%
2	0 - 255	GREEN 1-4 0% - 100%
3	0 - 255	BLUE 1-4 0% - 100%
4	0 - 255	RED 5-8 0% - 100%
5	0 - 255	GREEN 5-8 0% - 100%
6	0 - 255	BLUE 5-8 0% - 100%
7	0 - 255	RED 9-12 0% - 100%
8	0 - 255	GREEN 9-12 0% - 100%
9	0 - 255	BLUE 9-12 0% - 100%
10	0 - 15 16 - 255	STROBING NOTHING STROBING SLOW - FAST
11	0 - 255	MASTER DIMMER 0% - 100%

This DMX Channel mode can only be used when the unit is set to 3 Section Mode. See page 13.

Ultra Bar 12		18 Channel Mode
Channel	Value	Function
1	0 - 255	RED 1-2 0% - 100%
2	0 - 255	GREEN 1-2 0% - 100%
3	0 - 255	BLUE 1-2 0% - 100%
4	0 - 255	RED 3-4 0% - 100%
5	0 - 255	GREEN 3-4 0% - 100%
6	0 - 255	BLUE 3-4 0% - 100%
7	0 - 255	RED 5-6 0% - 100%
8	0 - 255	GREEN 5-6 0% - 100%
9	0 - 255	BLUE 5-6 0% - 100%
10	0 - 255	RED 7-8 0% - 100%
11	0 - 255	GREEN 7-8 0% - 100%
12	0 - 255	BLUE 7-8 0% - 100%
13	0 - 255	RED 9-10 0% - 100%
14	0 - 255	GREEN 9-10 0% - 100%
15	0 - 255	BLUE 9-10 0% - 100%
16	0 - 255	RED 11-12 0% - 100%
17	0 - 255	GREEN 11-12 0% - 100%
18	0 - 255	BLUE 11-12 0% - 100%

This DMX Channel mode can only be used when the unit is set to 6 Section Mode. See page 13.

Ultra Bar 12		20 Channel Mode
Channel	Value	Function
1	0 - 255	RED 1-2 0% - 100%
2	0 - 255	GREEN 1-2 0% - 100%
3	0 - 255	BLUE 1-2 0% - 100%
4	0 - 255	RED 3-4 0% - 100%
5	0 - 255	GREEN 3-4 0% - 100%
6	0 - 255	BLUE 3-4 0% - 100%
7	0 - 255	RED 5-6 0% - 100%
8	0 - 255	GREEN 5-6 0% - 100%
9	0 - 255	BLUE 5-6 0% - 100%
10	0 - 255	RED 7-8 0% - 100%
11	0 - 255	GREEN 7-8 0% - 100%
12	0 - 255	BLUE 7-8 0% - 100%
13	0 - 255	RED 9-10 0% - 100%
14	0 - 255	GREEN 9-10 0% - 100%
15	0 - 255	BLUE 9-10 0% - 100%
16	0 - 255	RED 11-12 0% - 100%
17	0 - 255	GREEN 11-12 0% - 100%

Ultra Bar 12		20 Channel Mode
Channel	Value	Function
18	0 - 255	BLUE 11-12 0% - 100%
19	0 - 15 16 - 255	STROBING NOTHING STROBING SLOW - FAST
20	0 - 255	MASTER DIMMER 0% - 100%

This DMX Channel mode can only be used when the unit is set to 6 Section Mode. See page 13.

Ultra Bar 12

Color Macro Chart

COLOR	RED	GREEN	BLUE
BASTARD AMBER	255	206	143
MEDIUM AMBER	254	177	153
PALE AMBER GOLD	254	192	138
GALLO GOLD	254	165	98
GOLDEN AMBER	254	121	0
LIGHT RED	176	17	0
MEDIUM RED	96	0	11
MEDIUM PINK	234	139	171
BROADWAY PINK	224	5	97
FOLLIES PINK	175	77	173
LIGHT LAVENDER	119	130	199
SPECIAL LAVENDER	147	164	212
LAVENDER	88	2	163
INDIGO	0	38	86
HEMSLEY BLUE	0	142	208
TIPTON BLUE	52	148	209
LIGHT STEEL BLUE	1	134	201
LIGHT SKY BLUE	0	145	212
SKY BLUE	0	121	192
BRILLIANT BLUE	0	129	184
LIGHT GREEN BLUE	0	83	115
BRIGHT BLUE	0	97	166
PRIMARY BLUE	1	100	167
CONGO BLUE	0	40	86
PALE YELLOW GREEN	209	219	182
MOSS GREEN	42	165	85
PRIMARY GREEN	0	46	35
DOUBLE CTB	8	107	222
FULL CTB	107	156	231
HALF CTB	165	198	247
DARK BLUE	0	0	189
WHITE	255	255	255
FULL RED	255	0	0
FULL GREEN	0	255	0
FULL BLUE	0	0	255

Ultra Bar 12

Photo Metric Chart

Ultra Bar 12

R	D40	1721.8	623.6	306.0	198.8	129.3	lux
G	D40	1736.4	625.5	298.4	189.5	110.3	
B	D40	1918.2	650.9	279.0	177.0	120.8	
RGB	D40	4909.1	1794.5	833.0	535.0	356.0	

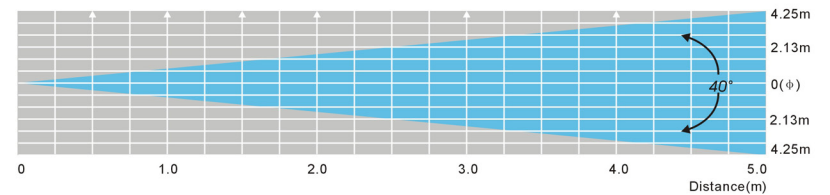

Ultra Bar 12

Power Cord Daisy Chain

With this feature you can connect the fixtures to one another using the IEC input and output sockets. The quantity that can be connected is 13 fixtures maximum. After 13 fixtures you will need to use a new power outlet. They must be the same fixtures. DO NOT mix fixtures.

Ultra Bar 12

Dimming Curves

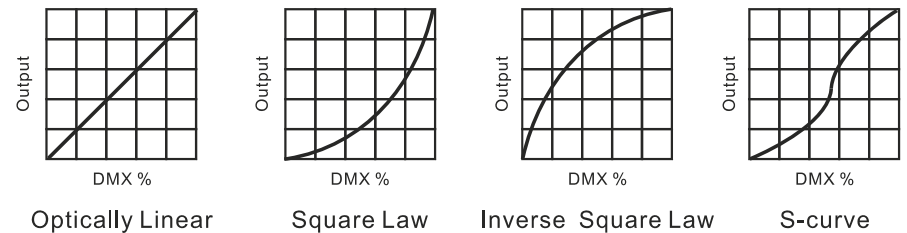

Ultra Bar 12

Fuse Replacement

Disconnect the unit from its power source. Remove the power cord from the unit. Once the cord has been removed, you will find that the fuse holder is located inside the power socket. Insert a flat-head screw driver into the power socket and gently pry out the fuse holder. Remove the bad fuse and replace with a new one. The fuse holder also has a holder for a spare fuse.

Ultra Bar 12

Trouble Shooting

Listed below are a few common problems the user may encounter, with solutions.

Unit not responding to DMX:

1. Check that the DMX cables are connected properly and are wired correctly (pin 3 is “hot”; on some other DMX devices pin 2 may be ‘hot’). Also, check that all cables are connected to the right connectors; it does matter which way the inputs and outputs are connected.

Unit does not respond to sound:

1. Quiet or high pitched sounds will not activate the unit.
2. Make sure that Sound Active mode is activated.

Ultra Bar 12

Cleaning

Due to fog residue, smoke, and dust cleaning the internal and external optical lenses must be carried out periodically to optimize light output.

1. Use normal glass cleaner and a soft cloth to wipe down the outside casing.
2. Clean the external optics with glass cleaner and a soft cloth every 20 days.
3. Always be sure to dry all parts completely before plugging the unit back in.

Cleaning frequency depends on the environment in which the fixture operates (i.e. smoke, fog residue, dust, dew).

Ultra Bar 12

Warranty

MANUFACTURER'S LIMITED WARRANTY

- A. ADJ Products, LLC hereby warrants, to the original purchaser, ADJ Products, LLC products to be free of manufacturing defects in material and workmanship for a prescribed period from the date of purchase (see specific warranty period on reverse). This warranty shall be valid only if the product is purchased within the United States of America, including possessions and territories. It is the owner's responsibility to establish the date and place of purchase by acceptable evidence, at the time service is sought.
- B. **For warranty service you must obtain a Return Authorization number (RA#) before sending back the product—please contact ADJ Products, LLC Service Department at 800-322-6337.** Send the product only to the ADJ Products, LLC factory. All shipping charges must be pre-paid. If the requested repairs or service (including parts replacement) are within the terms of this warranty, ADJ Products, LLC will pay return shipping charges only to a designated point within the United States. If the entire instrument is sent, it must be shipped in its original package. No accessories should be shipped with the product. If any accessories are shipped with the product, ADJ Products, LLC shall have no liability whatsoever for loss of or damage to any such accessories, nor for the safe return thereof.
- C. This warranty is void if the serial number has been altered or removed; if the product is modified in any manner which ADJ Products, LLC concludes, after inspection, affects the reliability of the product; if the product has been repaired or serviced by anyone other than the ADJ Products, LLC factory unless prior written authorization was issued to purchaser by ADJ Products, LLC; if the product is damaged because not properly maintained as set forth in the instruction manual.
- D. This is not a service contract, and this warranty does not include maintenance, cleaning or periodic check up. During the period specified above, ADJ Products, LLC will replace defective parts at its expense with new or refurbished parts, and will absorb all expenses for warranty service and repair labor by reason of defects in material or workmanship. The sole responsibility of ADJ Products, LLC under this warranty shall be limited to the repair of the product, or replacement thereof, including parts, at the sole discretion of ADJ Products, LLC. All products covered by this warranty were manufactured after August 15, 2012, and bear identifying marks to that effect.
- E. ADJ Products, LLC reserves the right to make changes in design and/or improvements upon its products without any obligation to include these changes in any products theretofore manufactured.

No warranty, whether expressed or implied, is given or made with respect to any accessory supplied with products described above. Except to the extent prohibited by applicable law, all implied warranties made by ADJ Products, LLC in connection with this product, including warranties of merchantability or fitness, are limited in duration to the warranty period set forth above. And no warranties, whether expressed or implied, including warranties of merchantability or fitness, shall apply to this product after said period has expired. The consumer's and/or Dealer's sole remedy shall be such repair or replacement as is expressly provided above; and under no circumstances shall ADJ Products, LLC be liable for any loss or damage, direct or consequential, arising out of the use of, or inability to use, this product.

This warranty is the only written warranty applicable to ADJ Products, LLC Products and supersedes all prior warranties and written descriptions of warranty terms and conditions heretofore published.

MANUFACTURER'S LIMITED WARRANTY PERIODS:

- **Lighting Products = 1-year (365 days) Limited Warranty** (Such as: Special Effect Lighting, Intelligent Lighting, UV lighting, Strobos, Fog Machines, Bubble Machines, Mirror Balls, Par Cans, Trussing, Lighting Stands etc. excluding LED and lamps)
- **Laser Products = 90-Day Limited Warranty**
- **L.E.D. Products = 3-year (1095 days) Limited Warranty** (excluding motors, PCB boards, and power supplies, which have a 1-year (365 day Limited Warranty) and batteries which have a 180 day limited warranty). Only the L.E.D.s carry a 3-year warranty

Model: Ultra Bar 12

Voltage:	100V ~ 240V/50~60Hz
LEDs:	12 x 3W TRI LEDs
Beam Angle:	40 Degrees
Working Position:	Any safe working position
Power Draw:	43W
Power Cord Daisy Chain:	13 Fixtures Max.
Fuse:	2 Amp
Weight:	6lbs./ 2.7Kgs.
Dimensions:	41.75" (L) x 2.5" (W) x 3.75" (H) 1060 x 63 x 90mm
Colors:	RGBA Color Mixing
DMX Channels:	9 DMX Modes: 3 Channel Mode, 5 Channel Mode, 6 Channel Mode, 7 Channel Mode, 8 Channel Mode, 9 Channel Mode, 11 Channel Mode, 18 Channel Mode, & 20 Channel Mode
Warranty:	3 Year (1,095 days) Limited Warranty

Auto Sensing Voltage: This fixture contains a automatic voltage switch, which will auto sense the voltage when it is plugged into the power source.

Please Note: Specifications and improvements in the design of this unit and this manual are subject to change without any prior written notice.

ADJ Products, LLC
6122 S. Eastern Ave. Los Angeles, CA 90040 USA
Tel: 323-582-2650 / Fax: 323-725-6100
Web: www.adj.com / E-mail: info@adj.com

A.D.J. Supply Europe B.V.
Junostraat 2
6468 EW Kerkrade
Netherlands

Follow Us On:



facebook.com/americanadj
twitter.com/americanadj
youtube.com/adjlighting

service@adjgroup.eu / www.adj.com
Tel: +31 45 546 85 00 / Fax: +31 45 546 85 99