

LED SmartArrays Data sheet 2014

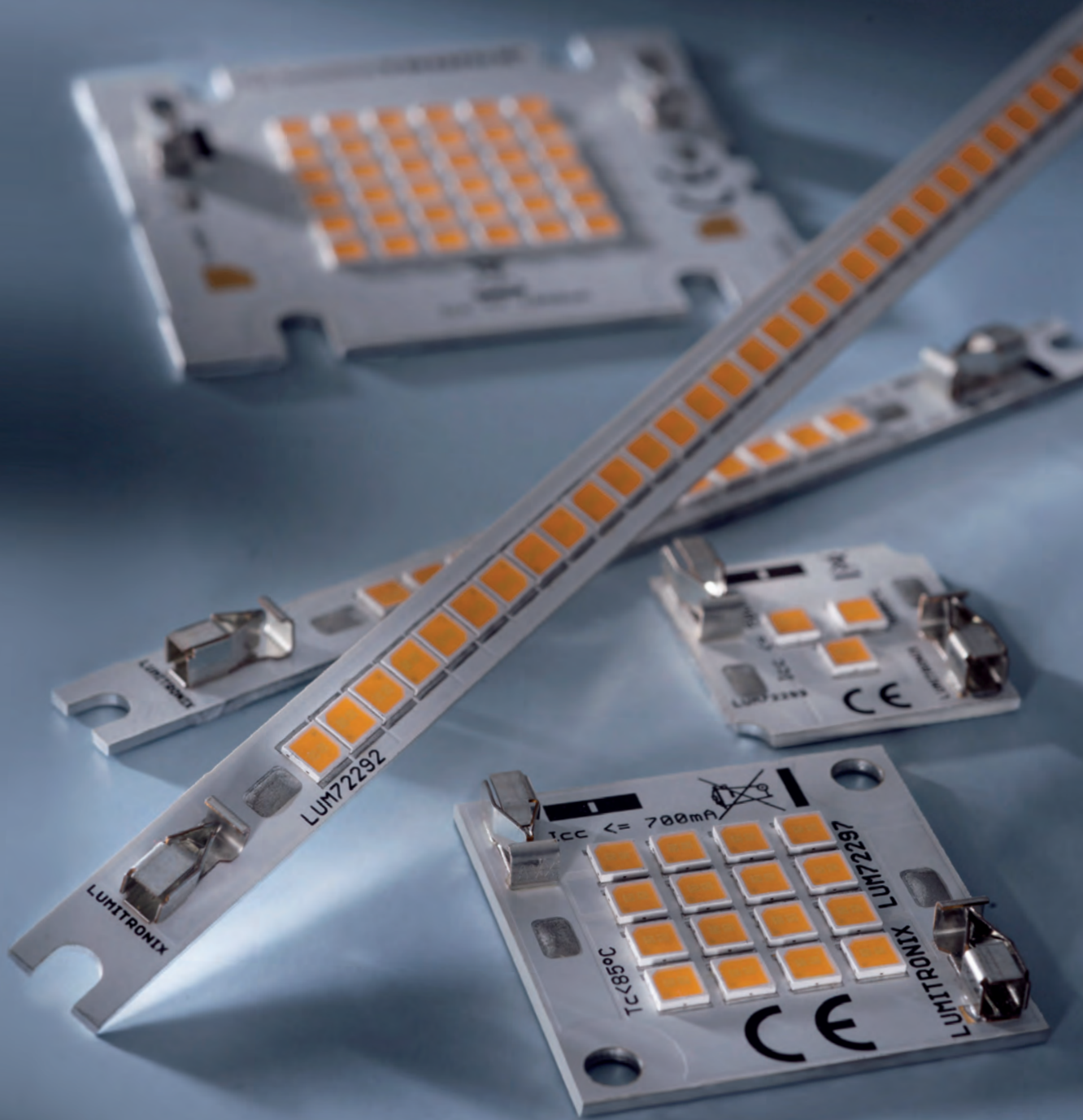

LED SmartArrays data sheet

CONTENTS

| | |
|-----------------------------------|----|
| Average flux | 3 |
| Environmental aspects | 3 |
| Warning notes | 3 |
| Contact with optical surfaces | 3 |
| Mechanical assembly | 3 |
| Eye safety | 3 |
| Burn injuries | 3 |
| Risks of chemical influence | 3 |
| Case temperature measuring point | 3 |
| Photobiological safety | 4 |
| Quick selection | 5 |
| Electrical characteristics | 6 |
| Absolute maximum ratings | 6 |
| Characteristics | 6 |
| Total Luminous Flux / Current | 7 |
| Total Luminous Flux / Temperature | 8 |
| Forward voltage / Current | 9 |
| Colorshift Δx / Current | 10 |
| Colorshift Δy / Current | 10 |
| Colorshift / Temperature | 11 |
| Installation | 12 |
| Cooling | 13 |
| Dimensions | 16 |

AVERAGE FLUX

LUMITRONIX predicts for the SmartArray – Series, that the luminous flux of the modules will be greater than 80% after 32700 hours when the modules are driven with constant current at a T_C -temperature of 85°C or less. The lifetime is defined by L80B50C1.

ENVIRONMENTAL ASPECTS

LUMITRONIX is anxious to only launch environmental-friendly products. The LUMITRONIX SmartArray modules are compliant to the restriction of hazardous substances directive 2011/65/EU. LUMITRONIX does not add lead, mercury, cadmium, hexavalent chromium 6, polybrominated biphenyls (PBB) or polybrominated diphenyl ethers (PBDEs) to the modules.

WARNING NOTES

Contact with optical surfaces

Do not touch the optical surface of the SmartArray modules. Avoid any contact to the optical surfaces.

Mechanical assembly

It's important to ensure that no conductor trace and no LED will be damaged. Also the solder resistive paint must not be displaced.

Eye safety

The classification of eye safety of the SmartArray modules follows the IEC-Specification EN62471: Photobiological safety of lamps and lamp systems. The classification into risk groups can be found in the CE-Certification. Suitable precautions must be taken. Employees should be trained in working with LEDs.

Burn injuries

Never touch the module or the optical surfaces while operation. Let the module cool down before handling it. The module can reach high temperatures that could cause burn injuries.

Risks of chemical influence

The influence of some chemicals that are used in the lighting manufacturing may cause reduction of the lifetime or the destruction of the modules.

Case temperature measuring point

The measuring point for measuring the temperature of the modules is given in the technical drawings.

WARNING NOTES

Photobiological safety

According to DIN EN 62471 (VDE 0837-471) lamps with lighting modules that are assigned to risk group 2 need to be marked.

| Designation | Color temperature | Eye UV | Bluelight | Retina thermal | Identification required |
|-------------|-------------------|--------|-----------|----------------|-------------------------|
| L3 | 2700K | RG 0 | RG 1 | RG 0 | No |
| L3 | 4000K | RG 0 | RG 1 | RG 0 | No |
| L6 | 2700K | RG 0 | RG 1 | RG 0 | No |
| L6 | 4000K | RG 0 | RG 1 | RG 0 | No |
| L9 | 2700K | RG 0 | RG 1 | RG 0 | No |
| L9 | 4000K | RG 0 | RG 1 | RG 0 | No |
| L12 | 2700K | RG 0 | RG 1 | RG 0 | No |
| L12 | 4000K | RG 0 | RG 1 | RG 0 | No |
| L16 | 2700K | RG 0 | RG 1 | RG 0 | No |
| L16 | 4000K | RG 0 | RG 1 | RG 0 | No |
| L25 | 2700K | RG 0 | RG 1 | RG 0 | No |
| L25 | 4000K | RG 0 | RG 1 | RG 0 | No |
| L36 | 2700K | RG 0 | RG 1 | RG 0 | No |
| L36 | 4000K | RG 0 | RG 1 | RG 0 | No |
| Q3 | 2700K | RG 0 | RG 1 | RG 0 | No |
| Q3 | 4000K | RG 0 | RG 1 | RG 0 | No |
| Q6 | 2700K | RG 0 | RG 1 | RG 0 | No |
| Q6 | 4000K | RG 0 | RG 1 | RG 0 | No |
| Q9 | 2700K | RG 0 | RG 1 | RG 0 | No |
| Q9 | 4000K | RG 0 | RG 1 | RG 0 | No |
| Q12 | 2700K | RG 0 | RG 1 | RG 0 | No |
| Q12 | 4000K | RG 0 | RG 1 | RG 0 | No |
| Q16 | 2700K | RG 0 | RG 1 | RG 0 | No |
| Q16 | 4000K | RG 0 | RG 1 | RG 0 | No |
| Q25 | 2700K | RG 0 | RG 1 | RG 0 | No |
| Q25 | 4000K | RG 0 | RG 1 | RG 0 | No |
| Q36 | 2700K | RG 0 | RG 1 | RG 0 | No |
| Q36 | 4000K | RG 0 | RG 1 | RG 0 | No |

QUICK SELECTION

| Designation | Dimensions | Color temperature | Current* | Voltage* | Flux* | Power* | Efficiency* | Energy class* |
|-------------|-------------|-------------------|----------|----------|-------|--------|-------------|---------------|
| | mm | Kelvin | l/mA | Vf/V | E/lm | P/W | n (lm/W) | |
| L3 | 50 x 7 | 2700K | 500 | 6,2 | 297 | 3,1 | 96 | A+ |
| L3 | 50 x 7 | 4000K | 500 | 6,2 | 340 | 3,1 | 110 | A++ |
| L6 | 50 x 7 | 2700K | 350 | 18,8 | 618 | 6,6 | 94 | A+ |
| L6 | 50 x 7 | 4000K | 350 | 18,8 | 708 | 6,6 | 108 | A+ |
| L9 | 72 x 7 | 2700K | 500 | 18,6 | 890 | 9,3 | 96 | A+ |
| L9 | 72 x 7 | 4000K | 500 | 18,6 | 1020 | 9,3 | 110 | A+ |
| L12 | 82 x 7 | 2700K | 700 | 18,8 | 1235 | 13,1 | 94 | A+ |
| L12 | 82 x 7 | 4000K | 700 | 18,8 | 1416 | 13,1 | 108 | A+ |
| L16 | 96,5 x 7 | 2700K | 700 | 25,0 | 1647 | 17,5 | 94 | A+ |
| L16 | 96,5 x 7 | 4000K | 700 | 25,0 | 1887 | 17,5 | 108 | A+ |
| L25 | 129 x 7 | 2700K | 1000 | 31,9 | 2865 | 31,9 | 90 | A+ |
| L25 | 129 x 7 | 4000K | 1000 | 31,9 | 3283 | 31,9 | 103 | A+ |
| L36 | 154,5 x 7 | 2700K | 1050 | 37,5 | 3706 | 39,4 | 94 | A+ |
| L36 | 154,5 x 7 | 4000K | 1050 | 37,5 | 4247 | 39,4 | 108 | A+ |
| Q3 | 19 x 19 | 2700K | 500 | 6,2 | 297 | 3,1 | 96 | A+ |
| Q3 | 19 x 19 | 4000K | 500 | 6,2 | 340 | 3,1 | 110 | A++ |
| Q6 | 19 x 19 | 2700K | 350 | 18,8 | 618 | 6,6 | 94 | A+ |
| Q6 | 19 x 19 | 4000K | 350 | 18,8 | 708 | 6,6 | 108 | A+ |
| Q9 | 28 x 28 | 2700K | 500 | 18,6 | 890 | 9,3 | 96 | A+ |
| Q9 | 28 x 28 | 4000K | 500 | 18,6 | 1020 | 9,3 | 110 | A+ |
| Q12 | 28 x 28 | 2700K | 700 | 18,8 | 1235 | 13,1 | 94 | A+ |
| Q12 | 28 x 28 | 4000K | 700 | 18,8 | 1416 | 13,1 | 108 | A+ |
| Q16 | 28 x 28 | 2700K | 700 | 25,0 | 1647 | 17,5 | 94 | A+ |
| Q16 | 28 x 28 | 4000K | 700 | 25,0 | 1887 | 17,5 | 108 | A+ |
| Q25 | 50,8 x 45,6 | 2700K | 1000 | 31,9 | 2865 | 31,9 | 90 | A+ |
| Q25 | 50,8 x 45,6 | 4000K | 1000 | 31,9 | 3283 | 31,9 | 103 | A+ |
| Q36 | 50,8 x 45,6 | 2700K | 1050 | 37,5 | 3706 | 39,4 | 94 | A+ |
| Q36 | 50,8 x 45,6 | 4000K | 1050 | 37,5 | 4247 | 39,4 | 108 | A+ |

* The values are given at $T_C = 85^\circ\text{C}$.

ELECTRICAL CHARACTERISTICS

| Designation | Forward voltage (V)* | | | Current (mA) |
|-------------|----------------------|------|------|--------------|
| | min. | typ. | max. | |
| L3 / Q3 | 5,8 | 6,5 | 7,2 | 500 |
| L6 / Q6 | 17,5 | 19,6 | 21,7 | 350 |
| L9 / Q9 | 17,4 | 19,5 | 21,6 | 500 |
| L12 / Q12 | 17,5 | 19,6 | 21,7 | 700 |
| L16 / Q16 | 23,3 | 26,1 | 28,9 | 700 |
| L25 / Q25 | 29,8 | 33,3 | 36,8 | 1000 |
| L36 / Q36 | 35 | 39,2 | 43,4 | 1050 |

* The values are given at $T_j = 25^\circ\text{C}$.

ABSOLUTE MAXIMUM RATINGS

| Parameter | Maximum rating |
|----------------------------|---------------------------|
| LED Junction temperature | 120°C |
| Storage temperature | -40°C - 105°C |
| Operating case-temperature | 105°C |
| Soldering temperature | 350°C or less, max. 3,5 s |

CHARACTERISTICS

Total Luminous Flux / Current

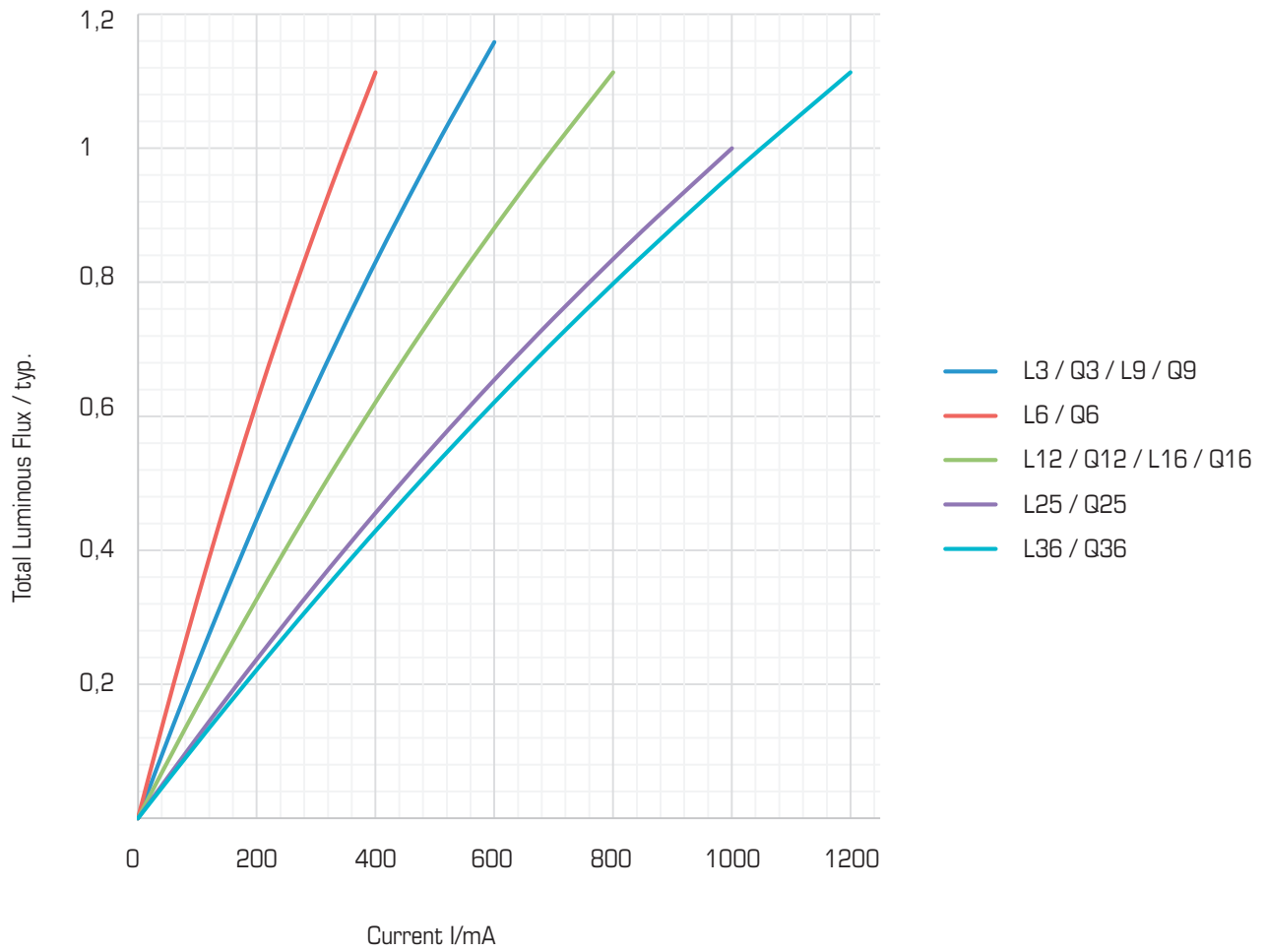

CHARACTERISTICS

Total Luminous Flux / Temperature

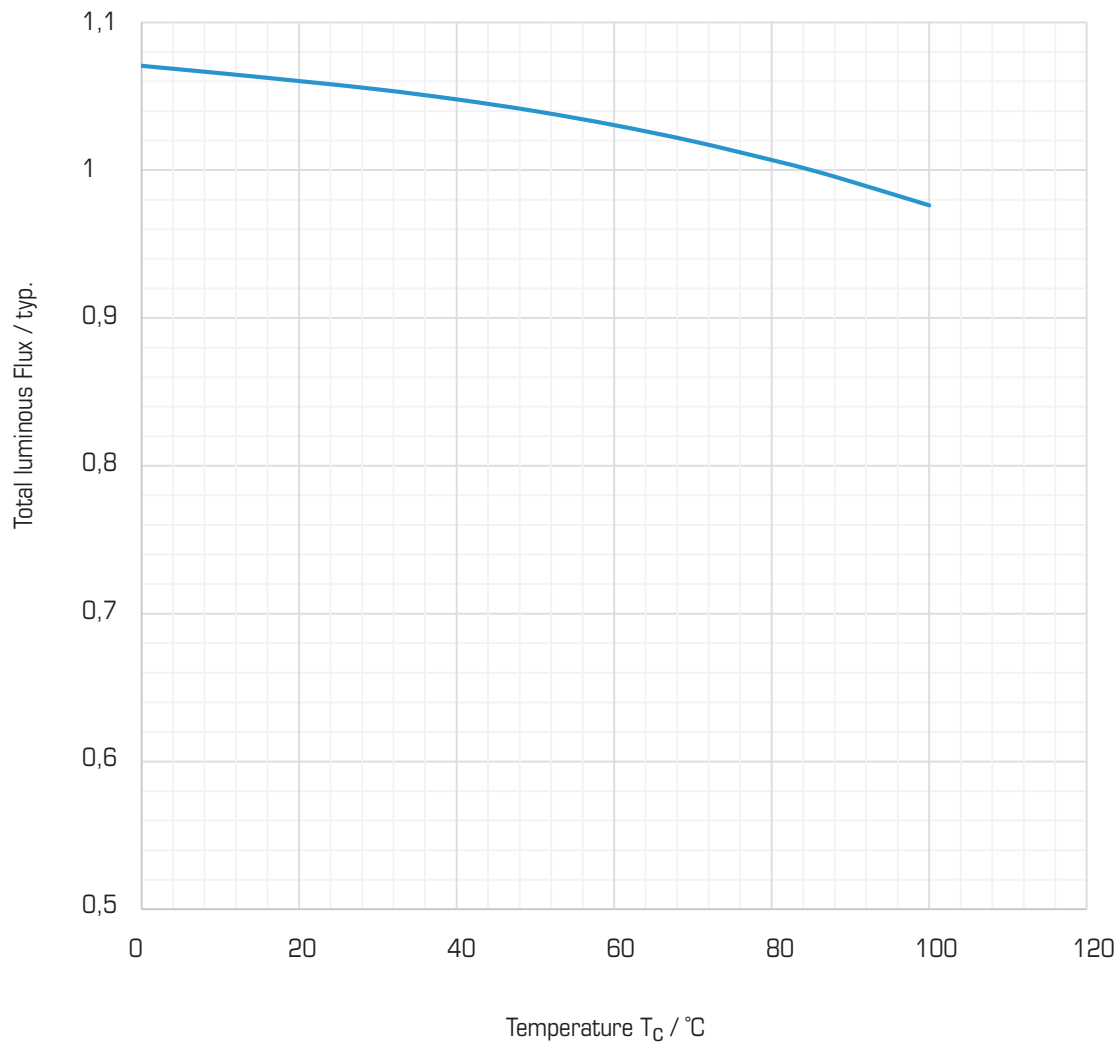

CHARACTERISTICS

Forward voltage / Current

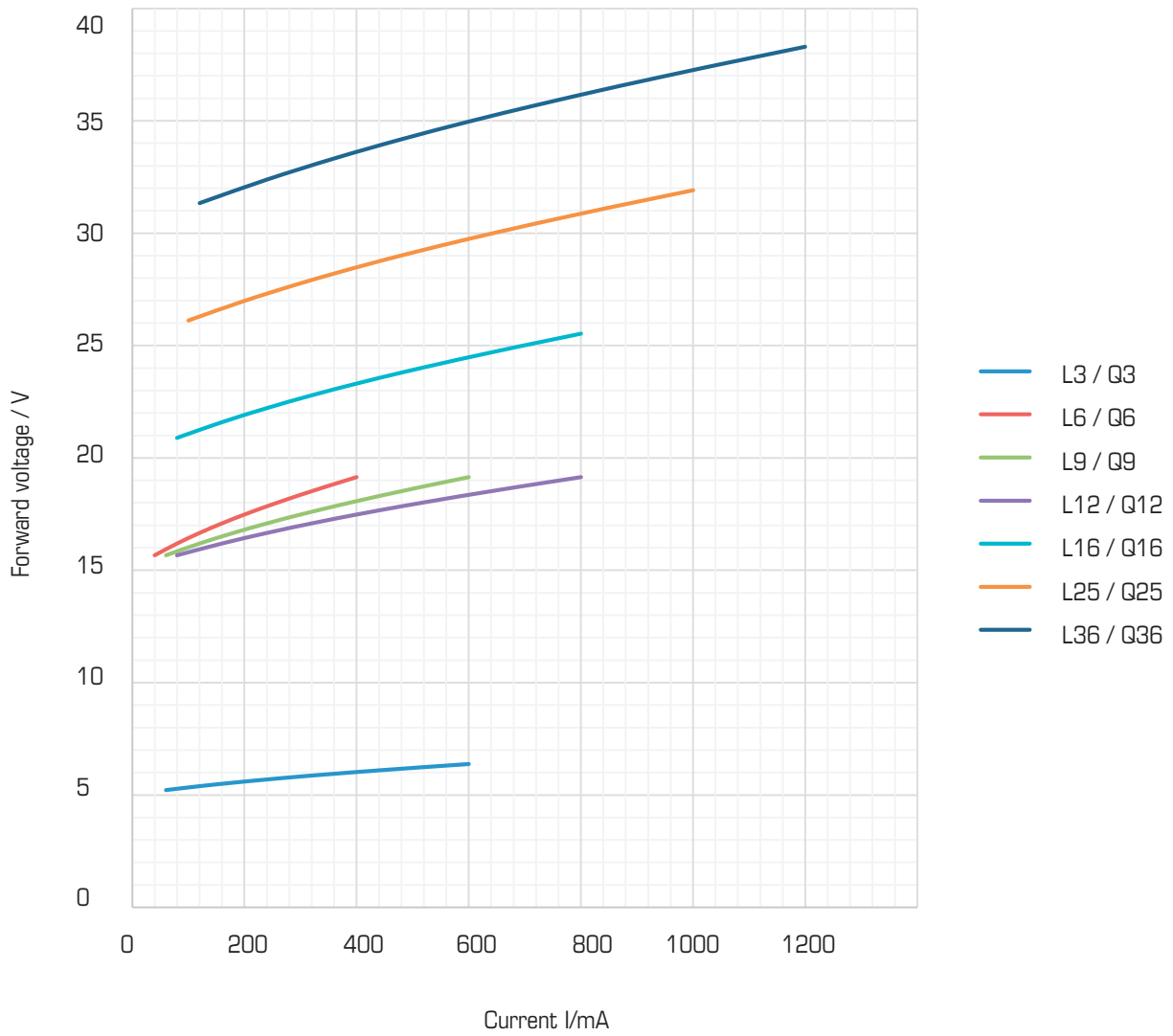

CHARACTERISTICS

Colorshift Δx / Current

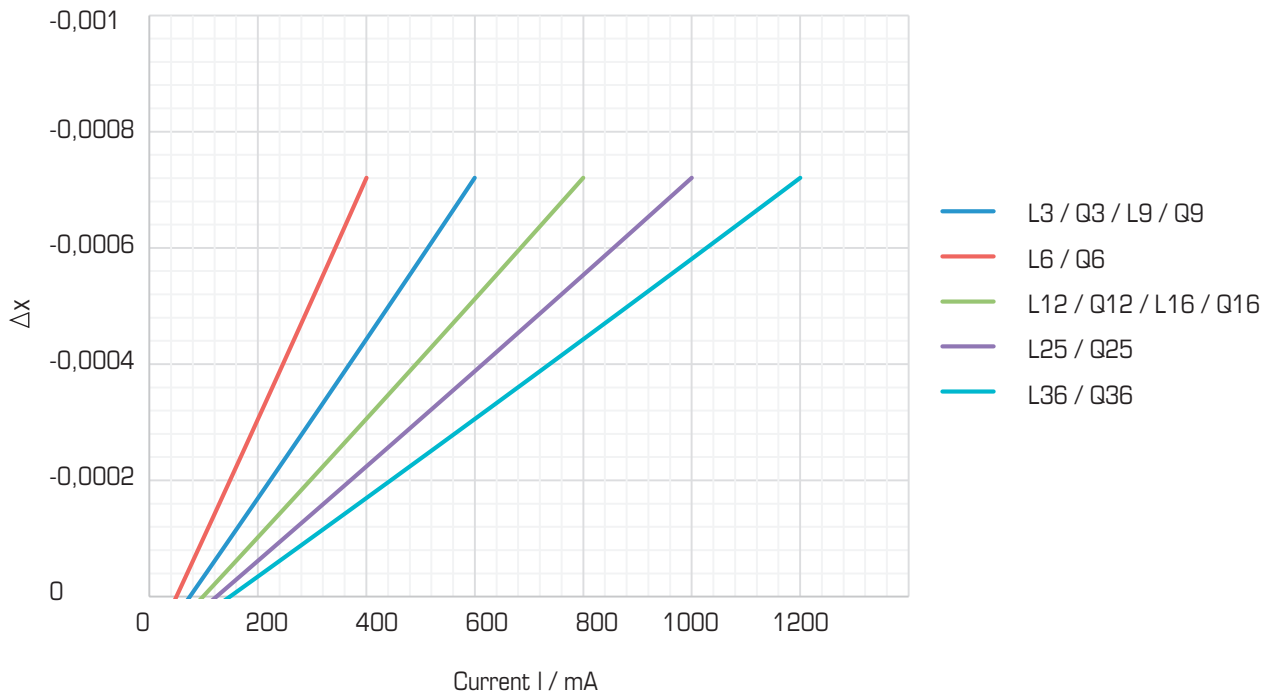

Colorshift Δy / Current

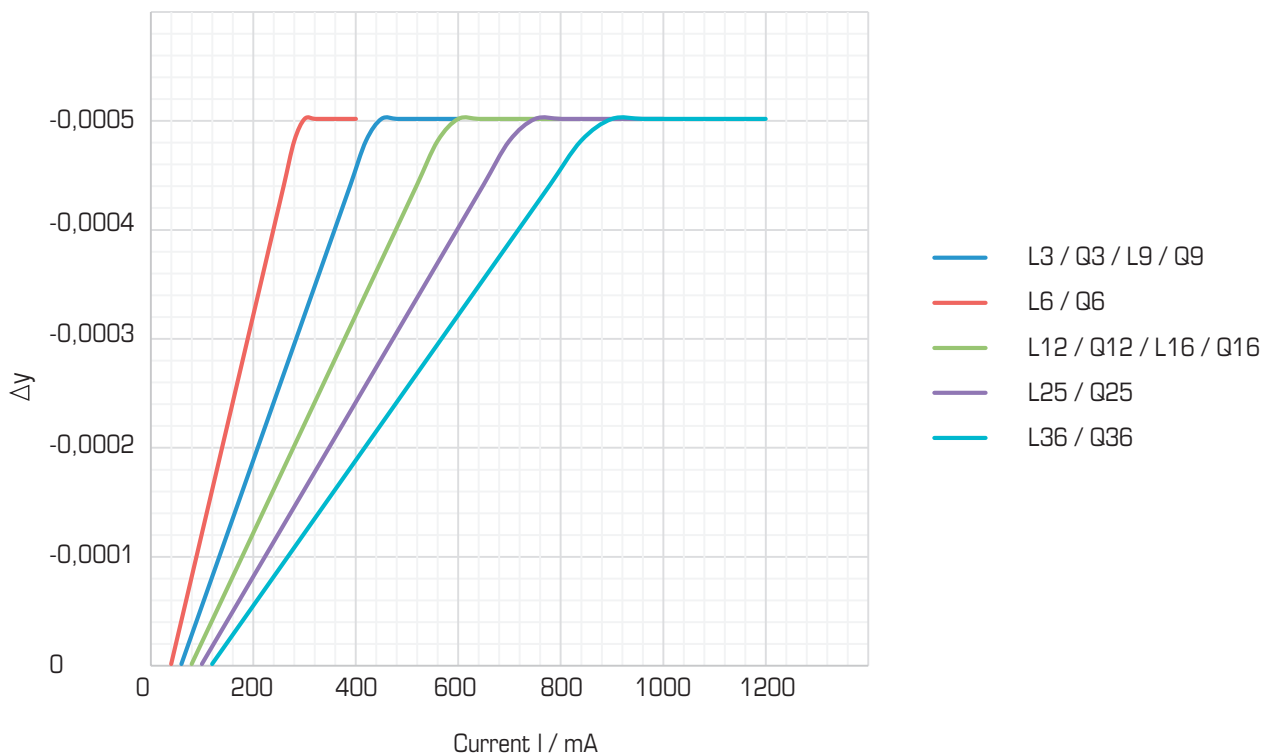

CHARACTERISTICS

Colorshift / Temperature

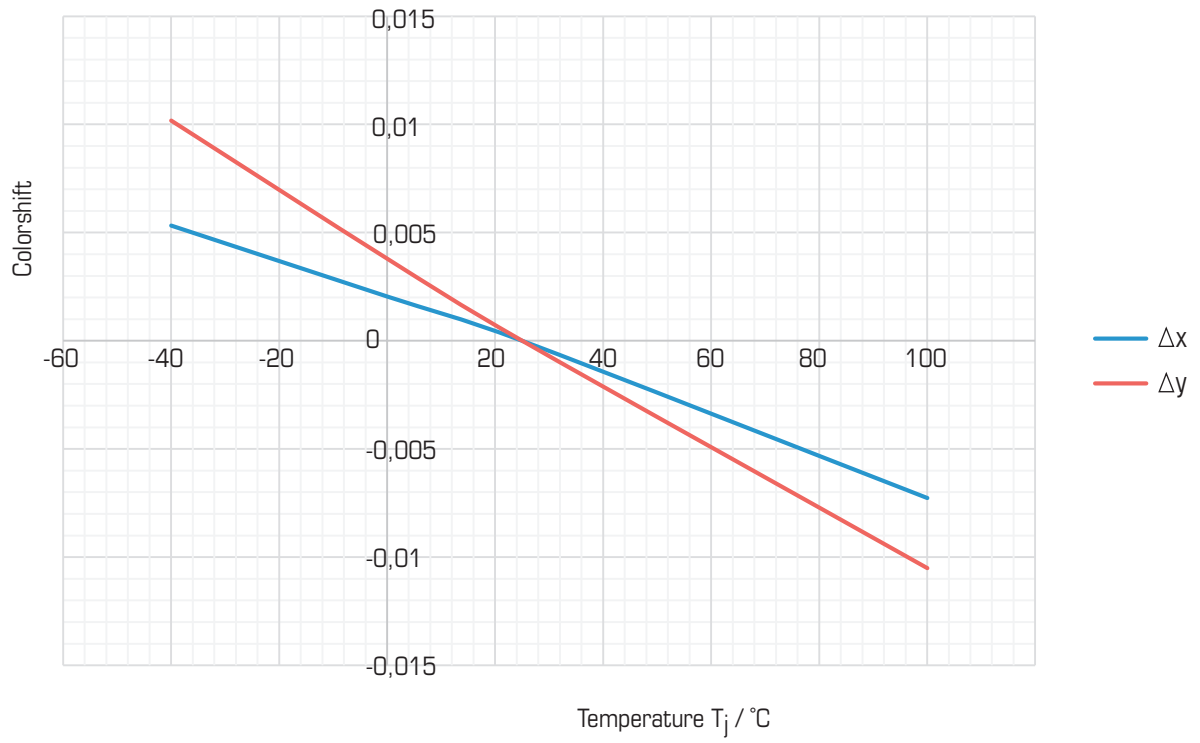

INSTALLATION

The back side of the SmartArray modules is covered with an adhesive tape. It is used to transfer the heat of the module to the cooling element.

The adhesive tape is covered by a protective foil. To install the SmartArray the foil needs to be removed. Do not touch the adhesive tape. The surface which the SmartArray will be stucked has to be smooth and clean. Soil (e.g. dust, dirt or oil) will deteriorate the adhesive force and the thermal resistance between the SmartArray and the cooling element.

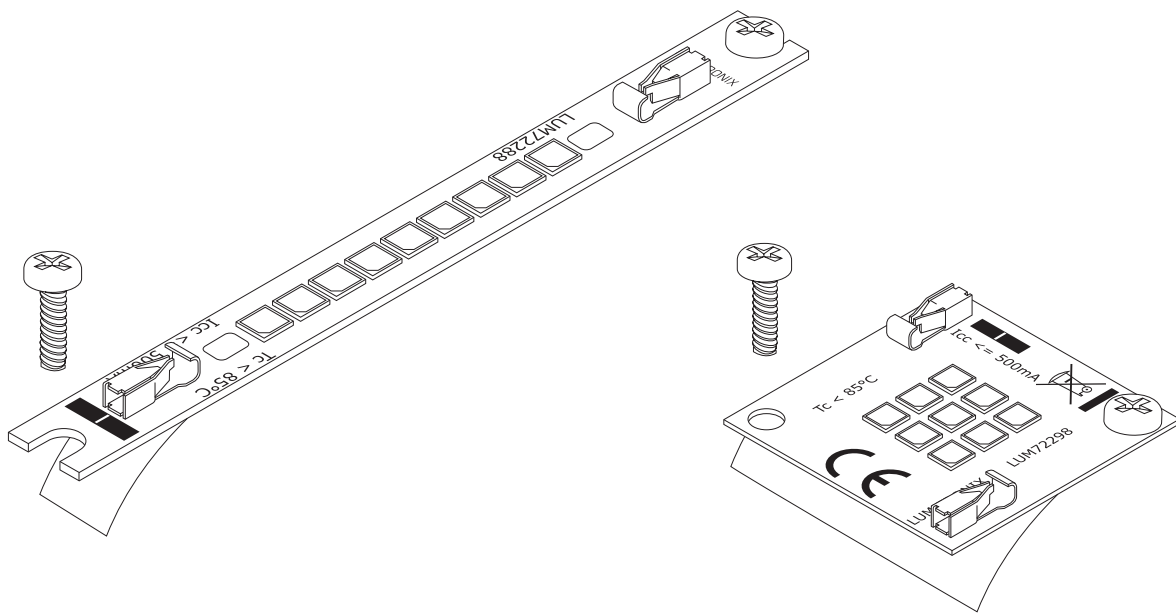

It is suggested to use suitable screws or clamps to mount the SmartArray permanently. The electrical connection is made by the connectors on the SmartArray. The connectors operate on the principle of springs. An inserted wire is hold in place by two clamps. The wire can be removed by twisting and gently pulling the cable out.

The L6 module is capable of wires with a profile of 28 AWG to 22 AWG (Isolation max. 1.5mm, stripping length 3.5 mm).

All the other SmartArray modules are capable of wires with a profile of 26 AWG to 18 AWG. (Isolation max. 2.5 mm, stripping length 3,5 mm)

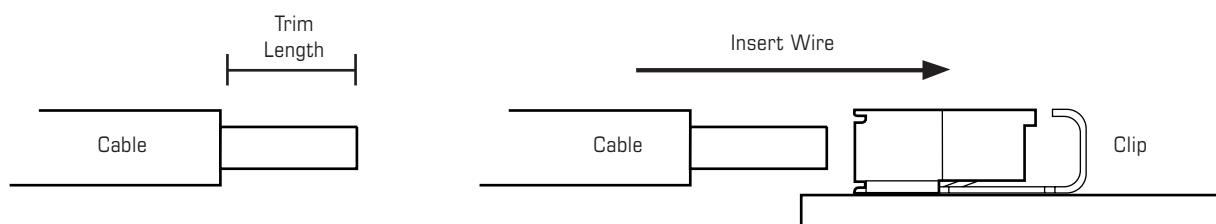

COOLING

Since the SmartArray modules produce heat, they need to be cooled. The cooling element must have a thermal resistance that is less than

$$R_{th} < \frac{85^{\circ}\text{C} - T_a}{P * 0,7}$$

In this equation T_a is the ambient temperature and P the power of the SmartArray module. As cooling elements heat sinks, active coolers or parts of the case can be used.

The thermal resistance R_{th} of a cooling element indicates, how big the temperature rise of a thermally connected element will be, when power is applied to it.

The unit of the thermal resistance is K/W. The thermal resistance can be calculated with the following equation:

$$R_{th} = \frac{\Delta T}{P} \quad (\text{equation 1})$$

Here ΔT is the difference between ambient and the heated spot and P is the applied Power.

To get the patching cooling element, the thermal resistance has to be calculated, so that the LED-Module will not exceed the maximum T_c Temperature whole operation.

The thermal power is proportional to the applied electrical power. About 30% of the power will be emitted as radiation power. So the thermal loss equals:

$$P = 0,7 * P_{el}. \quad (\text{equation 2})$$

COOLING

As example for the selection of the right cooling element:

1. $R_{th} \leq \frac{\Delta T}{P}$ (from equation 1)
2. $R_{th} \leq \frac{\Delta T}{0,7 * P_{el.}}$ (including equation 2)
3. $R_{th} \leq \frac{T_c - T_a}{0,7 * P_{el.}}$ (T_c = case-temperature, T_a = Ambient temperature)

The thermal path consists of the R_{th} of the cooling element and also the R_{th} of the cooling element and also the R_{th} of the PCB and the thermal adhesive.

4. $R_{th_KK} + R_{th_LP} \leq \frac{T_c - T_a}{0,7 * P_{el.}}$ After transposing the equation we get
5. $R_{th_KK} \leq \frac{T_c - T_a}{0,7 * P_{el.}} - R_{th_LP}$

For the SmartArrays can be assumed:

$$T_c = 85^\circ C \quad R_{th_LP} = 0,8 \text{ K/W}$$

This means $R_{th_KK} \leq \frac{85^\circ C - T_a}{0,7 * P_{el.}} - 0,8 \text{ K/W}$

The SmartArray Q36 will be used for the following.

The electrical power is the product of the rated current and forward voltage of the Module.

$$P_{el.} = I * U_f \quad (\text{equation 3})$$

If $I = 1050 \text{ mA}$ it results that $U_f = 37,5 \text{ V}$.

Therefore is $P_{el.} = 1,05 \text{ A} * 37,5 \text{ V} = 39,4 \text{ W}$.

To keep the case-temperature below $85^\circ C$ when the ambient temperature is $30^\circ C$ a cooling element with a thermal resistance of less than

$$R_{th_KK} \leq \frac{85^\circ C - 30^\circ C}{0,7 * 39,4 \text{ W}} - 0,8 \quad R_{th_KK} \leq 1,19 \text{ K/W}$$

is required.

COOLING

In this example the heat sink "SK 584" from Fischerelektronik can be used. The mounting area is big enough to cover the LED-Module and the thermal resistance is less than 1 K/W at a thickness of 50mm.

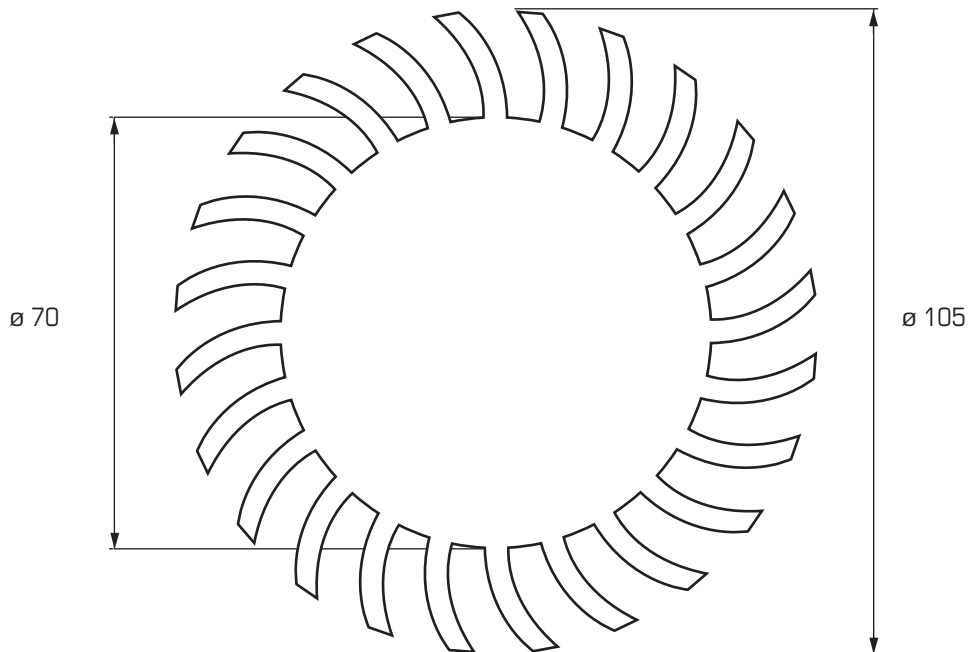

Geometry and length dependence of the SK 584

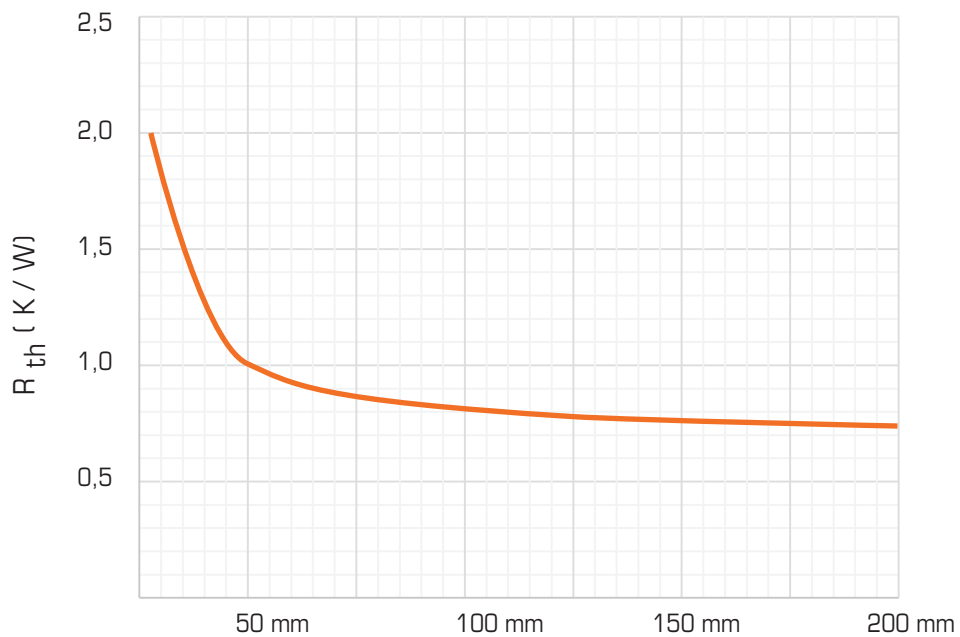

DIMENSIONS

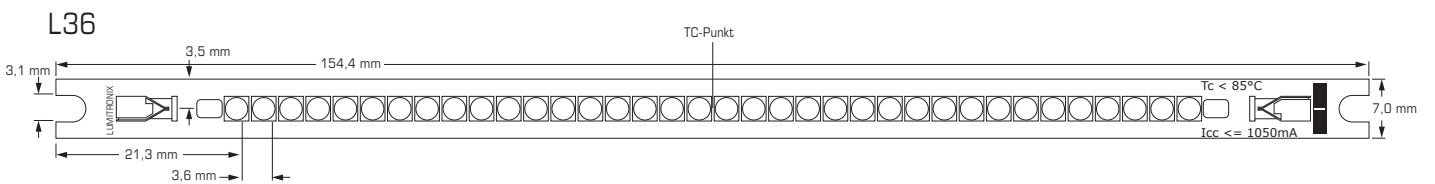
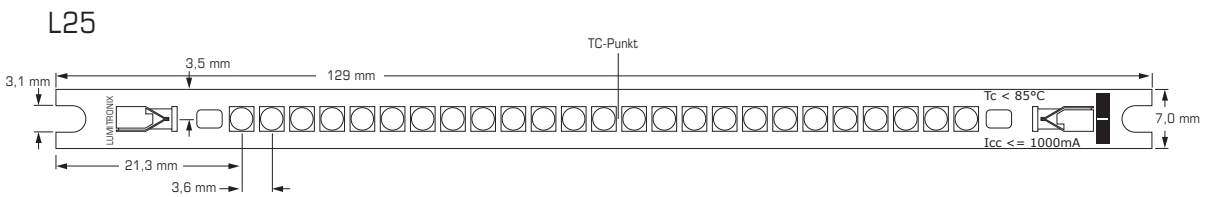
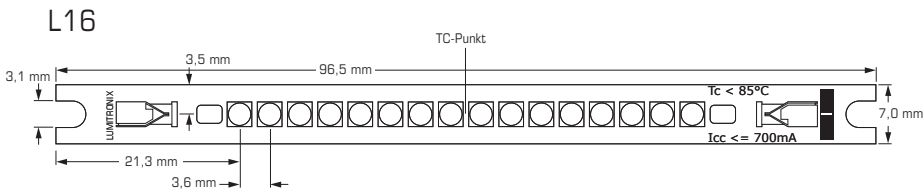
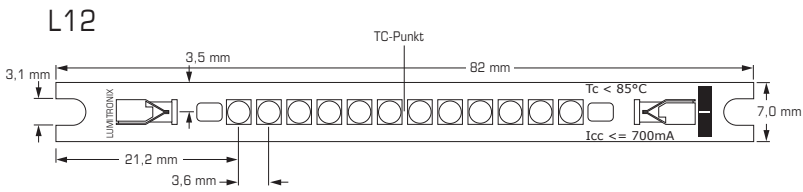
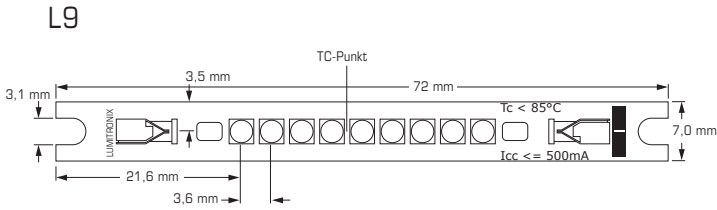
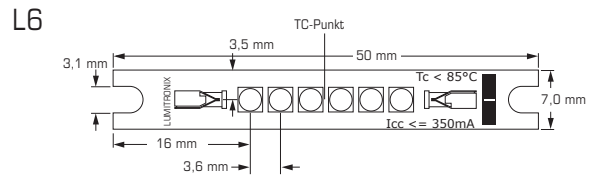
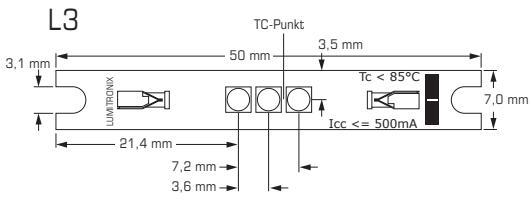

DIMENSIONS

Q3

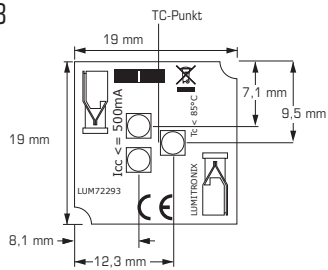

Q6

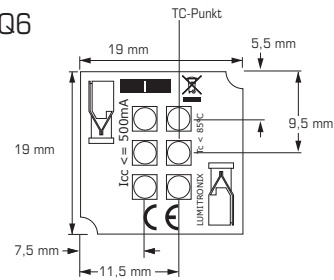

Q9

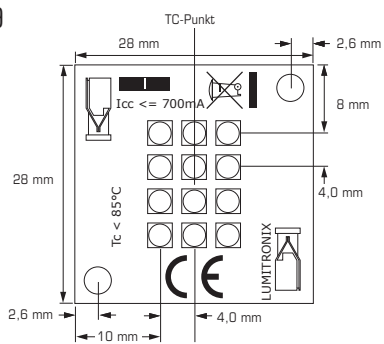

Q25

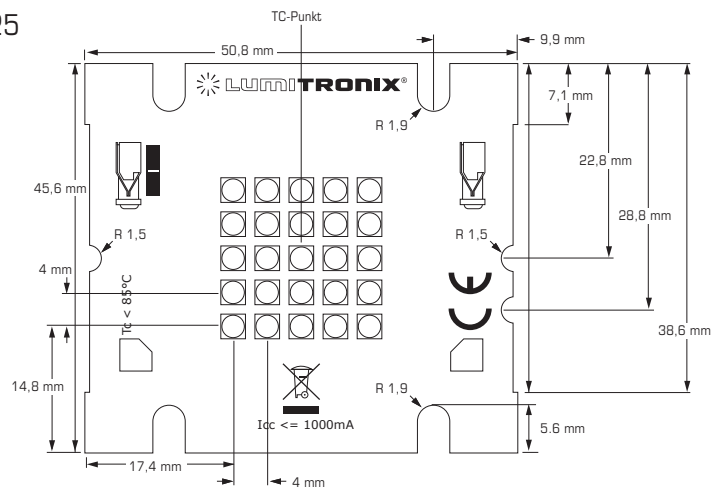

Q12

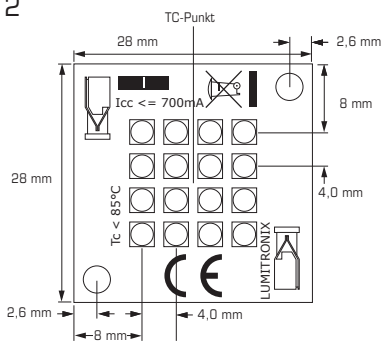

Q36

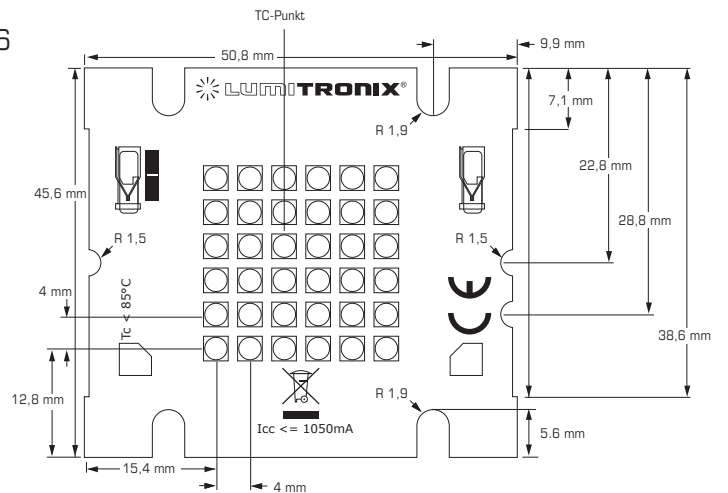

Q16

